



UPTOWN
LUXURY ELECTRIC FIREPLACES



PROUDLY DESIGNED IN THE
PACIFIC NORTHWEST

The perfect fireplace for any room

A fireplace is an incredible accent to have in your home. The cozy motion of a flickering flame and the comfortable warmth that can be felt throughout the room create a relaxing environment that you can't help but enjoy.

Uptown is removing the obstacles to this experience with our new line of beautiful electric fireplaces. These units can be installed in four separate styles and can be customized with a wide array of visual combinations. Find your perfect fireplace in this brochure or online at uptownfireplaces.com



BAY INSTALL



LINEAR INSTALL



LEFT CORNER INSTALL



RIGHT CORNER INSTALL





UE44 - Bay Installation, Western Timber Log Set

UE44
LUXURY ELECTRIC FIREPLACE

	HEIGHT	WIDTH	DEPTH
Visible Dimensions	20"	44"	10"



UE44 - Linear Installation, Traditional Log Set



UE44 - Right Corner Installation, Driftwood Log Set



UE56 - Bay Installation, Western Timber Log Set

UE56

LUXURY ELECTRIC FIREPLACE

	HEIGHT	WIDTH	DEPTH
Visible Dimensions	20"	56"	10"



UE56 - Right Corner Installation, Birch Log Set



UE56 - Linear Installation, Traditional Log Set



Western Timber

REAL WOOD LOG SET

HAND-CUT FROM REAL WOOD

Each Western Timber Log Set is individually handcrafted by our team of in-house artisans using real Douglas Fir logs sustainably harvested from the Pacific Northwest.

Each set is unique in the way logs are cut, burned, and distressed. Our unique process creates an incredibly realistic burn presentation that will continue to amaze for years to come.

Scan with your smartphone to learn more about the Western Timber Log set:
www.tinyurl.com/yh5zr2uh

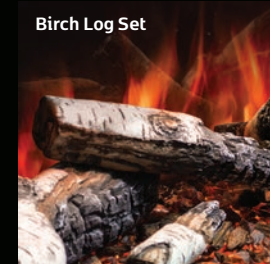

OR CHOOSE FROM OUR OTHER MEDIA OPTIONS





UE68 - Left Corner Installation, Driftwood Log Set

UE68

LUXURY ELECTRIC FIREPLACE

	HEIGHT	WIDTH	DEPTH
Visible Dimensions	20"	68"	10"



UE68 - Right Corner Installation, Western Timber Log Set



UE68 - Linear Installation, Traditional Log Set



UE80 - Bay Installation, Western Timber Log Set

UE80

LUXURY ELECTRIC FIREPLACE

	HEIGHT	WIDTH	DEPTH
Visible Dimensions	20"	80"	10"



UE80 - Bay Installation, Driftwood Log Set



UE80 - Linear Installation, Glacier Clear Glass

FEATURES & BENEFITS

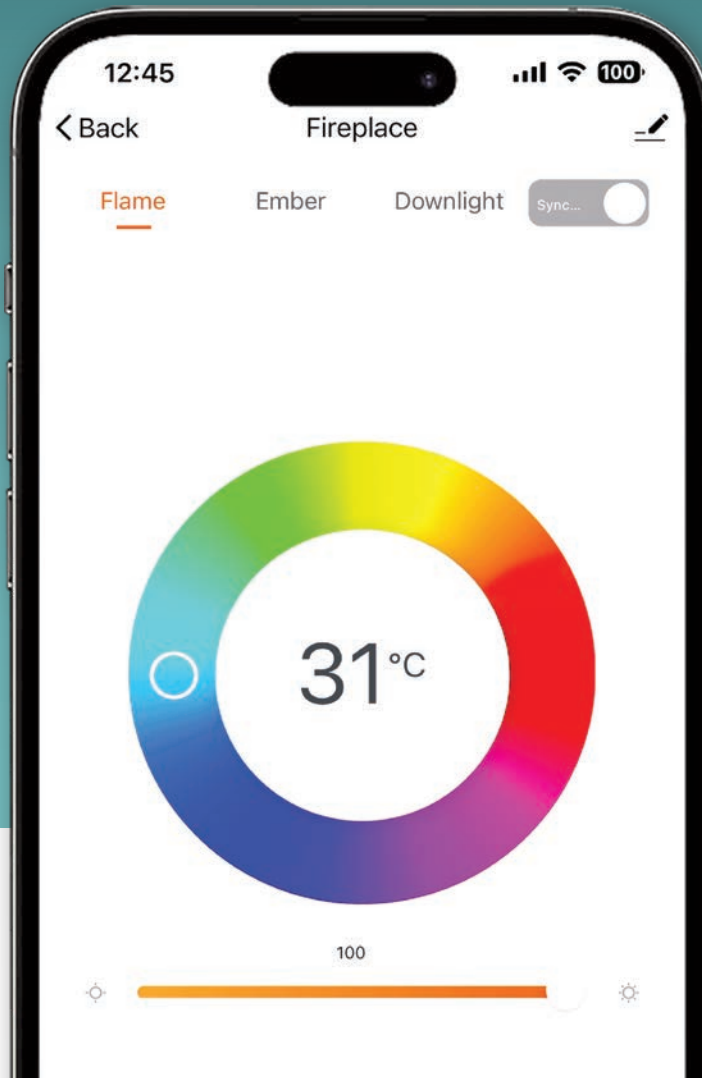

It's in the details...

Your purchase will stay in your home for generations so it's important to choose a fireplace that will come equipped with everything you could ask for, now and in the future. With our wide variety of features and options we are confident that you will be more than satisfied with your decision to choose Uptown Luxury Fireplaces.

- SMARTPHONE APP CONTROL
- TOUCH SENSITIVE REMOTE
- INCLUDED 5k BTU HEATER
- OPTIONAL 10K BTU HEATER
- VARIETY OF BURNER MEDIA
- FOUR INSTALL STYLES
- TOP & EMBER LIGHTING
- 3 YEAR WARRANTY
- DESIGNED IN NORTH AMERICA

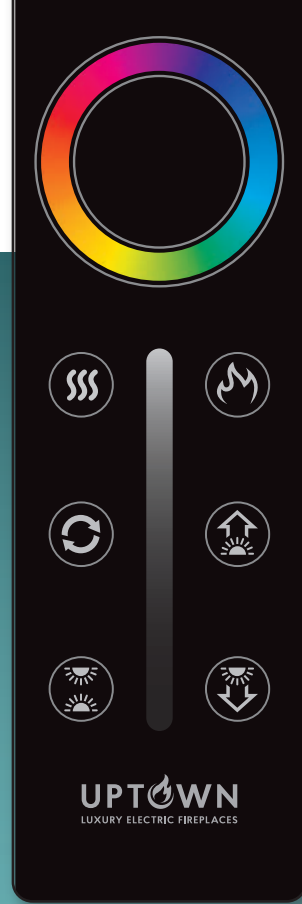

ONLINE FIREPLACE BUILDER

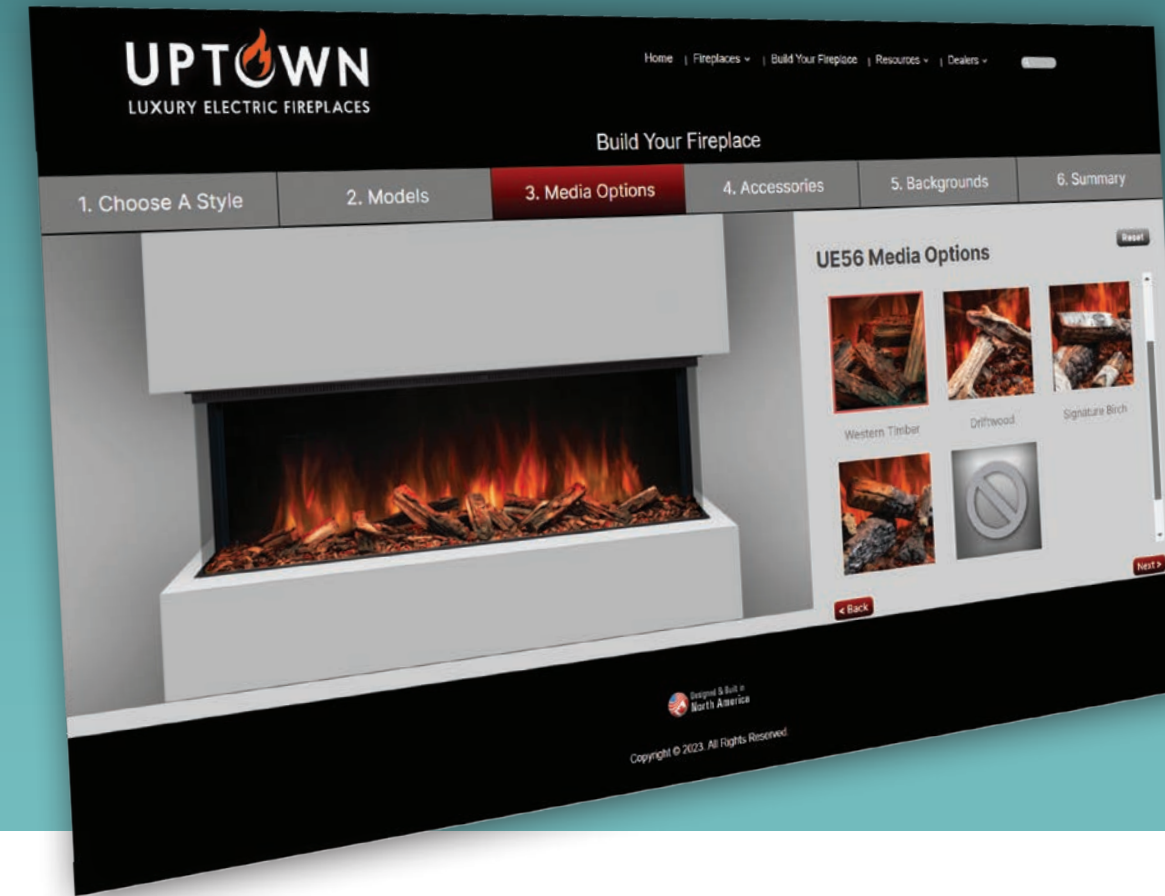

Build your dream fireplace today!

There are so many combinations to choose from with an Uptown Luxury Fireplace that we have created an online virtual builder to help you visualize your new fireplace before it's even in the wall. Use the builder to email yourself and your closest authorized dealership, a complete breakdown of your personalized fireplace.

Scan to visit our online builder at:
www.uptownfireplaces.com/fireplace-builder

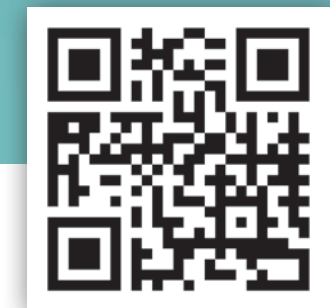

PRODUCT DIMENSIONS

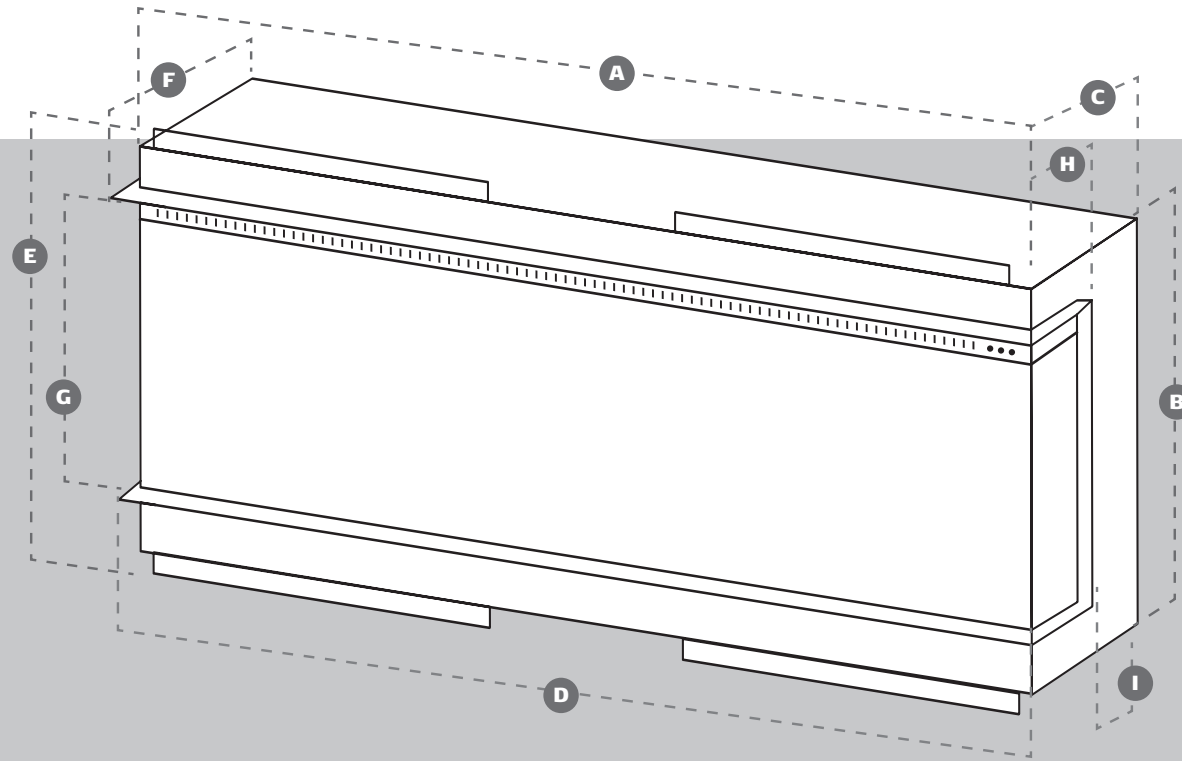

	UE44	UE56	UE68	UE80
A Width of firebox (not Including tiling flanges)	44 in 1118 mm	56 in 1422 mm	68 in 1727 mm	80 in 2032 mm
B Height of firebox (not Including mount brackets)	23.3 in 592 mm	23.3 in 592 mm	23.3 in 592 mm	23.3 in 592 mm
C Depth of firebox (not Including tiling flanges)	11.5 in 292 mm	11.5 in 292 mm	11.5 in 292 mm	11.5 in 292 mm
D Width of firebox (Including tiling flanges)	45.59 in 1158 mm	57.44 in 1459 mm	69.45 in 1764 mm	81.46 in 2069 mm
E Height of firebox (Including mount brackets)	25.79 in 655 mm	25.79 in 655 mm	25.79 in 655 mm	25.79 in 655 mm
F Depth of firebox (Including tiling flanges)	12.18 in 309 mm	12.18 in 309 mm	12.18 in 309 mm	12.18 in 309 mm
G Height of visible firebox (within the tiling flanges)	17.4 in 442 mm	17.4 in 442 mm	17.4 in 442 mm	17.4 in 442 mm
H Depth of the Glass (Side Glass)	7.26 in 189 mm	7.26 in 189 mm	7.26 in 189 mm	7.26 in 189 mm
I Remaining Depth of the Firebox (After the Glass)	4 in 102 mm	4 in 102 mm	4 in 102 mm	4 in 102 mm

FINISHING DIMENSIONS

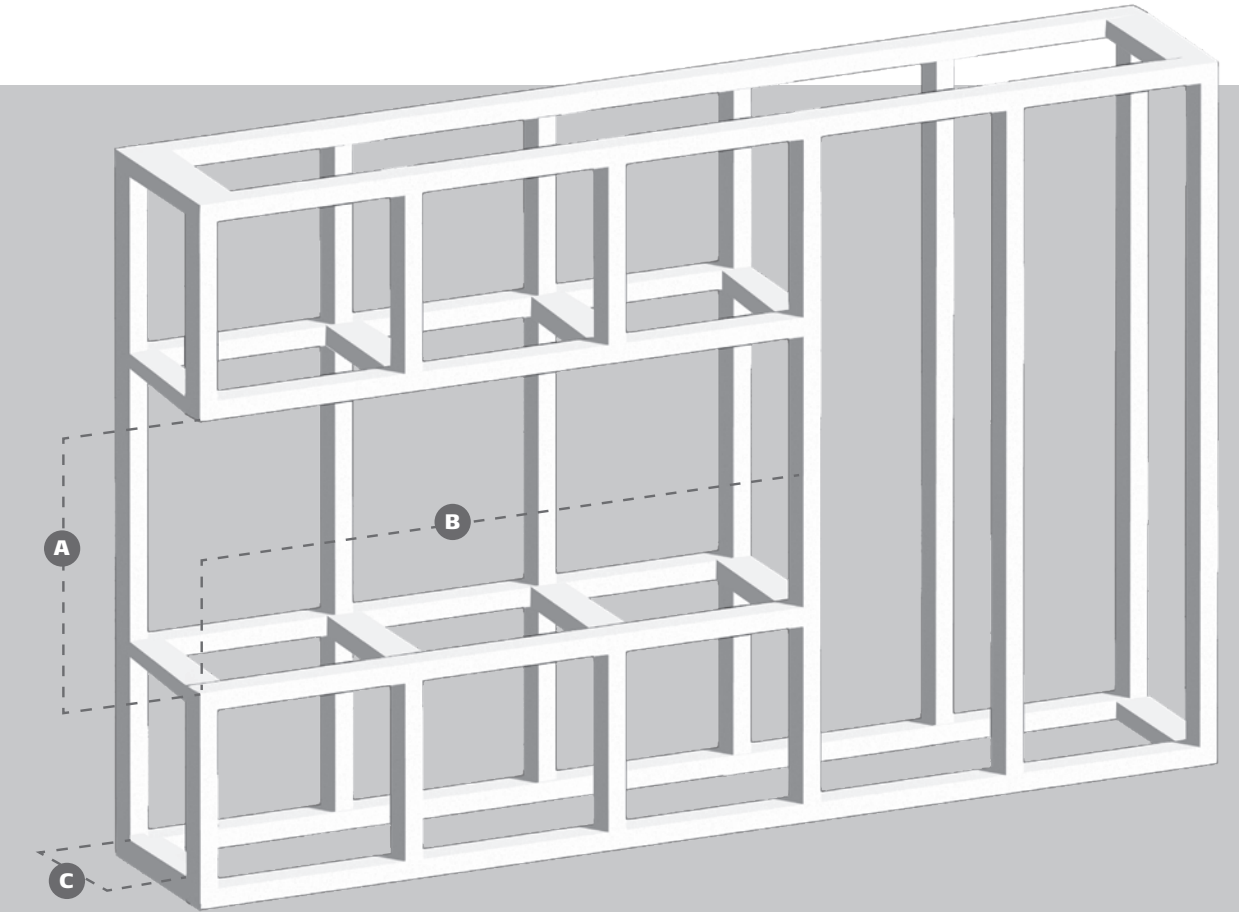

	UE44	UE56	UE68	UE80
A Framing Height	23 7/8 in 606 mm	23 7/8 in 606 mm	23 7/8 in 606 mm	23 7/8 in 606 mm
B Framing Width	44 5/16 in 1126 mm	56 5/16 in 1430 mm	68 5/16 in 1735 mm	80 5/16 in 2040 mm
C Minimum Framing Depth	11 7/8 in 302 mm	11 7/8 in 302 mm	11 7/8 in 302 mm	11 7/8 in 302 mm



A product of Sherwood Industries Ltd. Victoria, BC, Canada | uptownfireplaces.com
Printed in Canada, December 2023

