

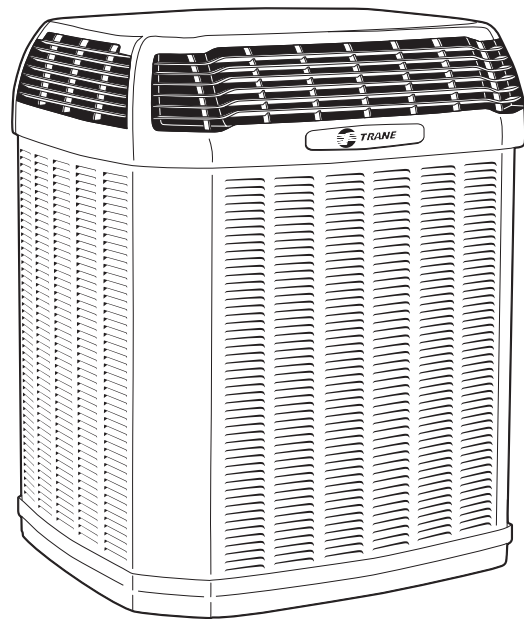

Product Data

Split System Heat Pump XL17i 2, 3, 4 & 5 Tons

4TWX7024E1000A
4TWX7036E1000A
4TWX7048E1000A
4TWX7060E1000A



*Note: "Graphics in this document are for representation only.
Actual model may differ in appearance."*



Features and Benefits

- **CLIMATUFF™** 2-stage scroll compressor
- Efficiency up to **17.0 SEER** and **9.5 HSPF**
- All Aluminum **SPINE FIN™** coil
- **WEATHERGUARD™ II** top shields unit
- **DURATUFF™** weather proof and rust proof base
- **COMFORT "R"™** mode approved for better comfort indoors
- **QUICK-SESS™** cabinet, service access and refrigerant connections with full coil protection
- **WEATHERGUARD™** fasteners
- Glossy corrosion resistant finish tarpaulin gray cabinet with anthracite gray top
- Internal compressor high/low pressure & temperature protection
- Liquid line filter/drier
- Low sound with advanced variable speed fan motor
- Service valve cover
- R-410A refrigerant
- From 70 to 100% capacity modulation
- 100% run test in the factory
- Low ambient cooling to 55° as shipped
- **Extended warranties available**

Contents

Features and Benefits	2
General Data	4
Product Specifications	4
A-weighted Sound Power Level [dB(A)]	4
Accessory Description and Usage	5
AHRI Standard Capacity Rating Conditions	5
Model Nomenclature	6
Electrical Data	7
Dimensions	13
Mechanical Specifications	14



General Data

Product Specifications

Model No. ①	4TWX7024E1000A	4TWX7036E1000A	4TWX7048E1000A	4TWX7060E1000A
Electrical Data V/Ph/Hz ②	208/230/1/60	208/230/1/60	208/230/1/60	208/230/1/60
Min Cir Ampacity	15	20	27	36
Max Fuse Size (Amps)	25	35	45	60
Compressor	CLIMATUFF® - SCROLL	CLIMATUFF® - SCROLL	CLIMATUFF® - SCROLL	CLIMATUFF® - SCROLL
No. Used - No. Stages	1-2	1-2	1-2	1-2
RL AMPS - LR AMPS	11.7 - 58.3	15.3 - 83	21.2 - 104	26.9 - 152.9
Outdoor Fan FL Amps	0.77	0.77	0.93	2.80
Fan HP	1/8	1/8	1/5	1/3
Fan Dia (inches)	27.6	27.6	27.6	27.6
Coil	Spine Fin™	Spine Fin™	Spine Fin™	Spine Fin™
Refrigerant R-410A	10/03-LBS/OZ	10/15-LBS/OZ	12/9-LBS/OZ	12/10-LBS/OZ
Line Size - (in.) O.D. Gas ③	5/8	3/4	7/8	1-1/8
Line Size - (in.) O.D. Liquid ③	3/8	3/8	3/8	3/8
Dimensions H x W x D (Crated)	51.6 x 35.1 x 38.7	55.6 x 35.1 x 38.7	55.6 x 35.1 x 38.7	55.6 x 35.1 x 38.7
Weight - Shipping	305	307	360	361
Weight - Net	257	257	310	311
Start Components	NO (Use BAYKSKT263)	NO (Uses BAYKSKT266)	NO (Use BAYKSKT263)	NO (Use BAYKSKT266)
Sound Enclosure	NO	NO	NO	NO
Compressor Sump Heat	YES	YES	YES	YES
Optional Accessories: ④				
Rubber Isolator Kit	BAYISLT101	BAYISLT101	BAYISLT101	BAYISLT101
Snow Leg - Base & Cap 4" High	BAYLEGS002	BAYLEGS002	BAYLEGS002	BAYLEGS002
Snow Leg - 4" Extension	BAYLEGS003	BAYLEGS003	BAYLEGS003	BAYLEGS003
Hard Start Kit Scroll	BAYKSKT263	BAYKSKT266	BAYKSKT263	BAYKSKT266
Extreme Condition Mounting Kit	BAYECMT004	BAYECMT004	BAYECMT004	BAYECMT004
Vertical Discharge Air Kit Base 4	BAYVDTA003	BAYVDTA004	BAYVDTA004	BAYVDTA004
Auto Charge Solenoid Kit	BAYCAKT001	BAYCAKT001	BAYCAKT001	BAYCAKT001
Refrigerant Lineset ⑤				

① Certified in accordance with the Air-Source Unitary Heat Pump Equipment certification program which is based on AHRI Standard 210/240.

② Calculated in accordance with N.E.C. Only use HACR circuit breakers or fuses.

③ Standard line lengths - 60'. Standard lift - 25' Suction and Liquid line.

For Greater lengths and lifts refer to refrigerant piping software Pub# 32-3312-0*. (*denotes latest revision)

④ For accessory description and usage, see page 5.

⑤ 25, 30, 35 and 50 foot linesets available. For a complete listing of lineset options available from equipment or supply stores, refer to the Trane Residential and Light Commercial Product Handbook.

Sound Power Level

Model	A-Weighted Sound Power Level [dB(A)]	Full Octave Sound Power [dB]							
		63 Hz	125 Hz	250 Hz	500 Hz	1000 Hz	2000 Hz	4000 Hz	8000 Hz
4TWX7024E	72	67	67	62	63	62	57	55	50
4TWX7036E	72	66	66	64	64	63	57	54	48
4TWX7048E	72	68	73	65	67	63	56	53	47
4TWX7060E	74	58	75	66	68	66	59	55	52

Note: Rated in accordance with AHRI Standard 270-2008

General Data

Accessory Description and Usage

Rubber Isolators — 5 rubber donuts to isolate condensing unit from mounting frame or pad. Use on any application where sound transmission needs to be minimized.

Extreme Conditions Mounting Kit — Bracket kits to securely mount condensing unit to a frame or pad without removing any panels. Use in areas with high winds, or on commercial rooftops, etc.

Low Ambient Cooling — For low ambient cooling below 55° see Application Guide APP-APG013-EN.

AHRI Standard Capacity Rating Conditions

AHRI STANDARD 210/240 RATING CONDITIONS —

- (A) Cooling 80°F DB, 67°F WB air entering indoor coil, 95°F DB air entering outdoor coil.
- (B) High Temperature Heating 47°F DB, 43°F WB air entering outdoor coil, 70°F DB air entering indoor coil.
- (C) Low Temperature Heating 17°F DB, 15°F WB air entering outdoor coil, 70°F DB air entering indoor coil.
- (D) Rated indoor airflow for heating is the same as for cooling.

AHRI STANDARD 270 RATING CONDITIONS — (Noise rating numbers are determined with the unit in cooling operation.) Standard Noise Rating number is at 95°F outdoor air.



Model Nomenclature

Outdoor Units

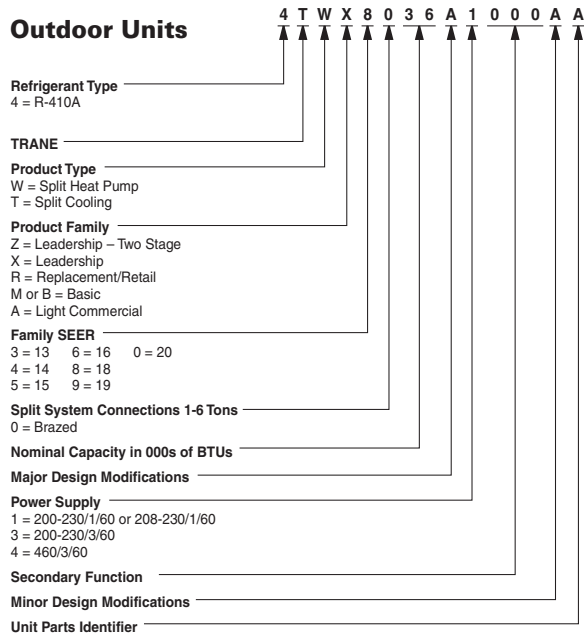

Gas Furnaces

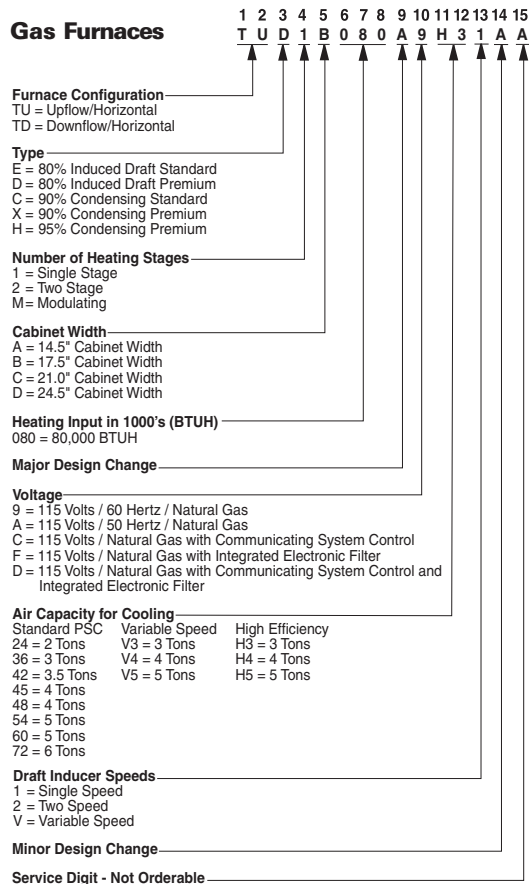

Air Handler

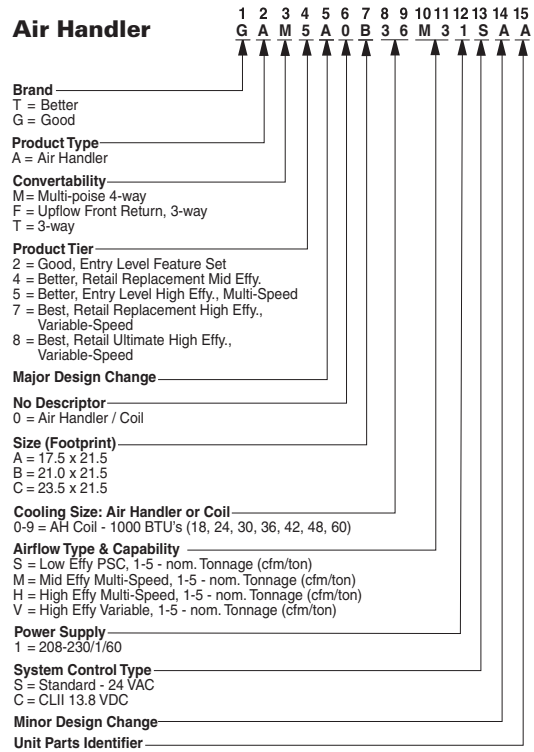

Heat Pump/ Cooling Coils

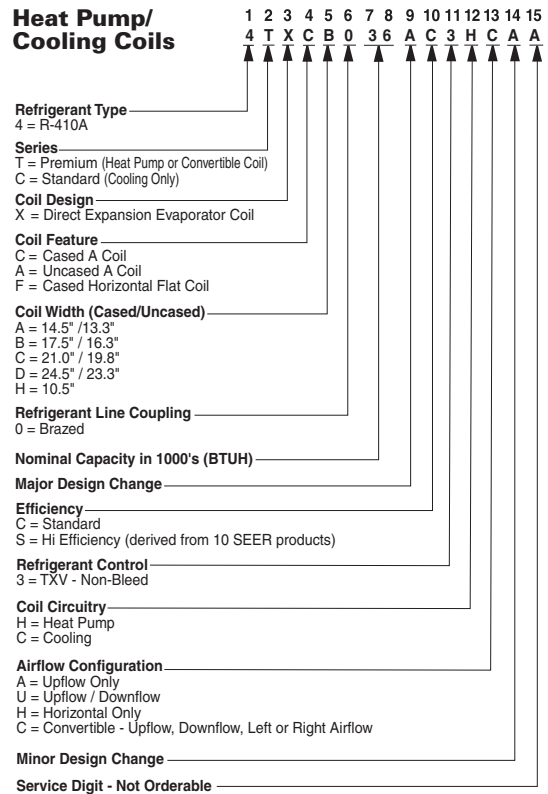

Electrical Data

Schematic Diagrams 2 Ton Units

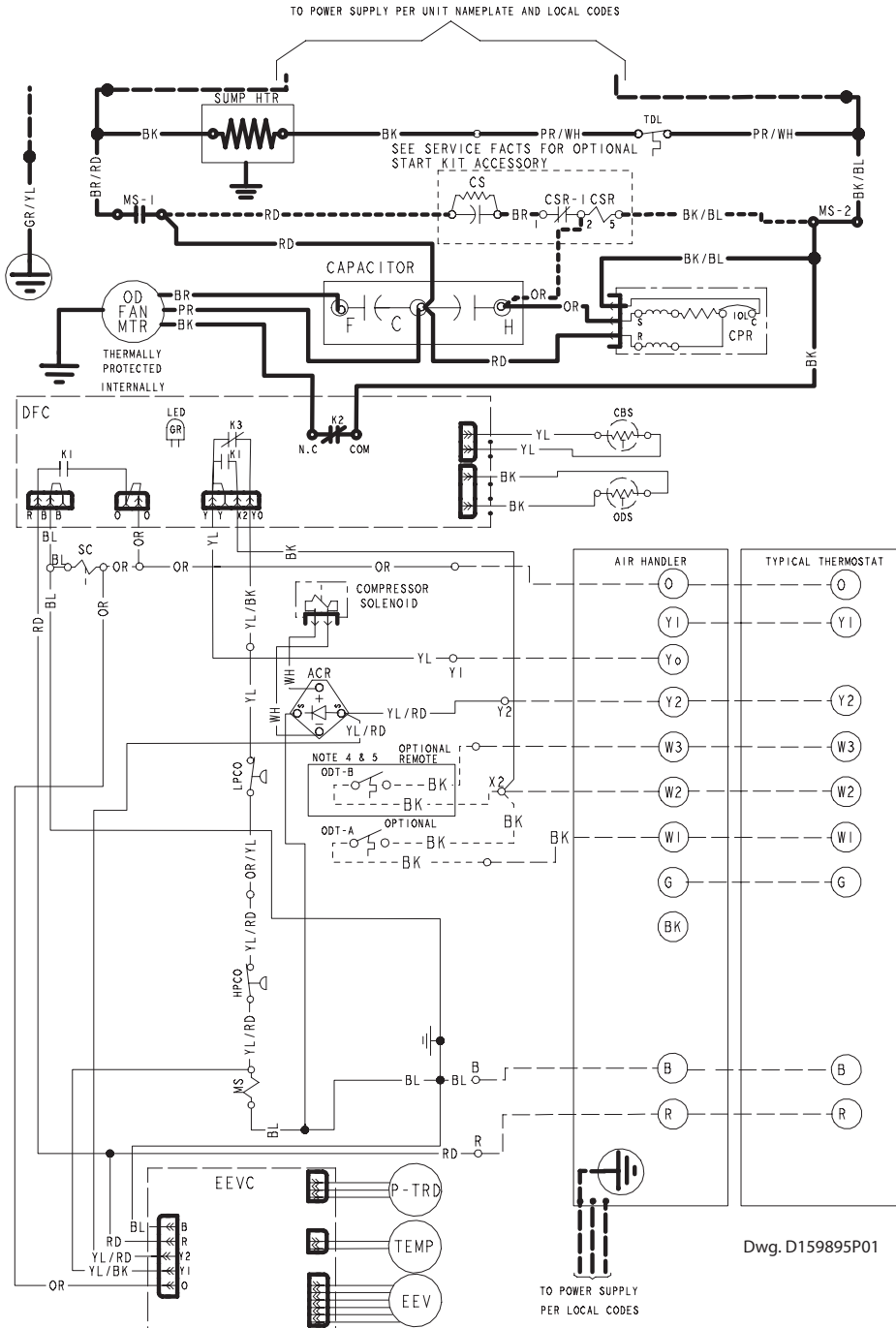

- ACR A/C RECTIFIER
- CBS COIL BOTTOM SENSOR
- CF FAN CAPACITOR
- CN WIRE CONNECTOR
- CPR COMPRESSOR
- CR RUN CAPACITOR
- CS STARTING CAPACITOR
- CSR CAPACITOR SWITCHING RELAY
- DFC DEFOUST CONTROL
- EEV ELECTRONIC EXP VALVE
- EEVC ELECTRONIC EXP VALVE CONTROL
- F INDOOR FAN RELAY
- HPCO HIGH PRESSURE CUTOFF SWITCH
- IOL INTERNAL OVERLOAD PROTECTOR
- LPCC LOW PRESSURE CUTOFF SWITCH
- MS COMPRESSOR MOTOR CONTACTOR
- ODA OUTDOOR ANTICIPATOR
- OFT OUTDOOR FAN THERMOSTAT
- ODS OUTDOOR TEMPERATURE SENSOR
- ODT OUTDOOR THERMOSTAT
- P-TRD PRESSURE TRANSDUCER
- SC SWITCH OVER VALVE SOLENOID
- SN SYSTEM ON-OFF SWITCH
- TDL DISCHARGE LINE THERMOSTAT
- TDR TIME DELAY RELAY (5 SEC DELAY ON)
- TNS TRANSFORMER
- TEMP SENSOR, TEMPERATURE
- Y2C HIGH CAPACITY CONTROL RELAY

WARNING
HAZARDOUS VOLTAGE!
DISCONNECT ALL ELECTRICAL POWER INCLUDING REMOTE DISCONNECTS BEFORE SERVICING.
Failure to disconnect power before servicing can cause severe personal injury or death.

CAUTION
USE COPPER CONDUCTORS ONLY!
UNIT TERMINALS ARE NOT DESIGNED TO ACCEPT OTHER TYPES OF CONDUCTORS.
Failure to do so may cause damage to the equipment.

- NOTES:
1. BE SURE POWER SUPPLY AGREES WITH EQUIPMENT NAMEPLATE.
 2. POWER WIRING AND GROUNDING OF EQUIPMENT MUST COMPLY WITH LOCAL CODES.
 3. LOW VOLTAGE WIRING TO BE NO. 18 AWG MINIMUM CONDUCTOR.
 4. ODT-B MUST BE SET LOWER THAN ODT-A
 5. IF ODT-B IS NOT USED, CONNECT A JUMPER WIRE FROM W3 TO W2. IF ODT-A IS NOT USED, CONNECT A JUMPER WIRE FROM W2 TO W1.
 6. IF ELECTRIC HEATER DOES NOT HAVE A 3RD CONTACTOR (CH), CONNECT A JUMPER WIRE FROM W3 TO W2. IF ELECTRIC HEATER DOES NOT HAVE A 2ND CONTACTOR (BH), CONNECT A JUMPER WIRE FROM W2 TO W1.
 7. WITH Y1 ENERGIZED, INDOOR FAN IS 1ST STAGE AIRFLOW.
 8. WITH Y1 & Y2 ENERGIZED, INDOOR FAN IS 2ND STAGE AIRFLOW.
 9. SEE AIR HANDLER INSTALLER GUIDE FOR DIP SWITCH CONFIGURATIONS.

FOR CANADIAN INSTALLATIONS
POUR INSTALLATIONS CANADIENNES

**CAUTION: NOT SUITABLE FOR USE ON SYSTEMS EXCEEDING 150V TO-GROUND
ATTENTION: NE CONVIENT PAS AUX INSTALLATIONS DE PLUS DE 150 V A LA TERRE**

Electrical Data

Schematic Diagrams 2 Ton Units

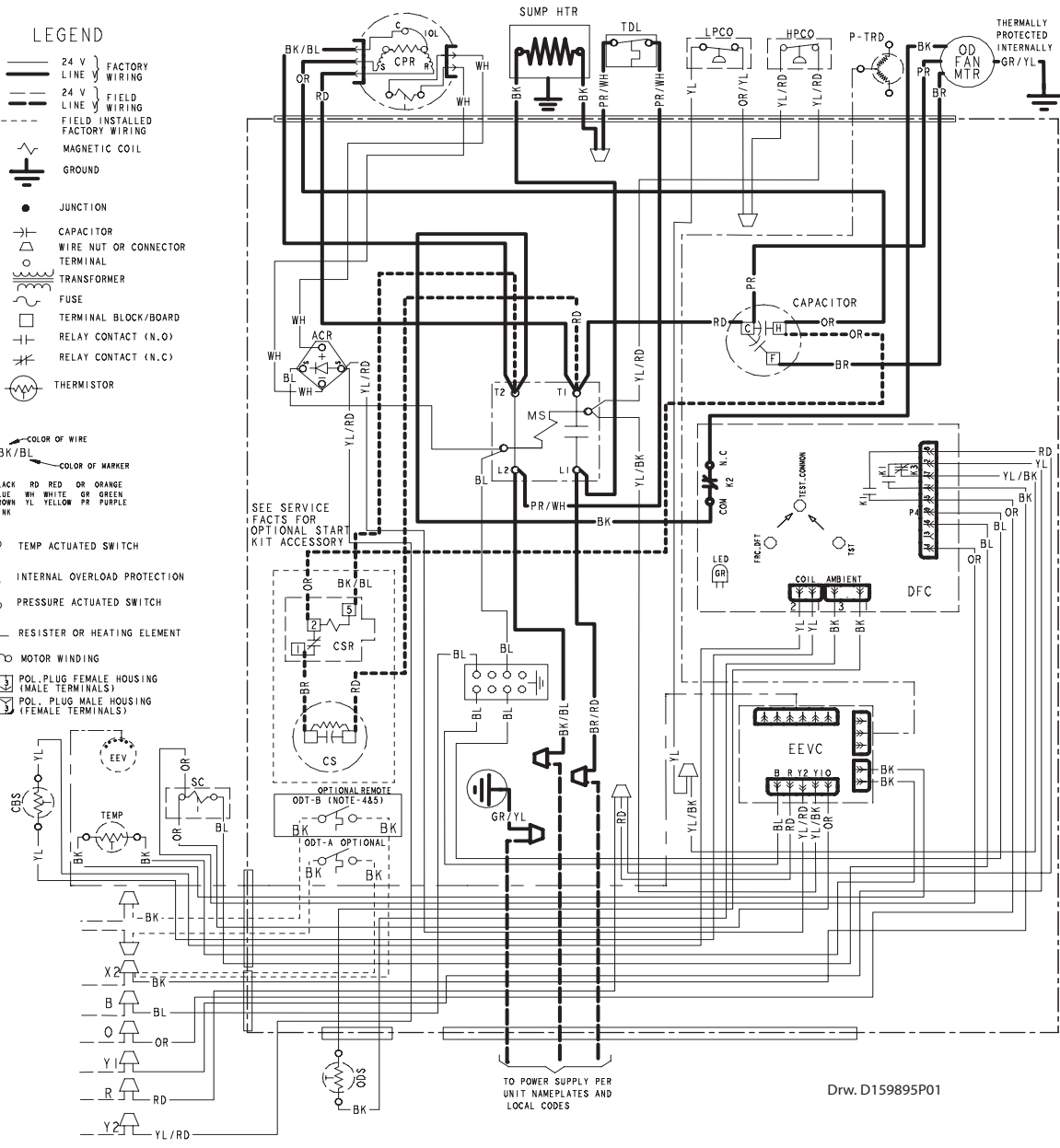
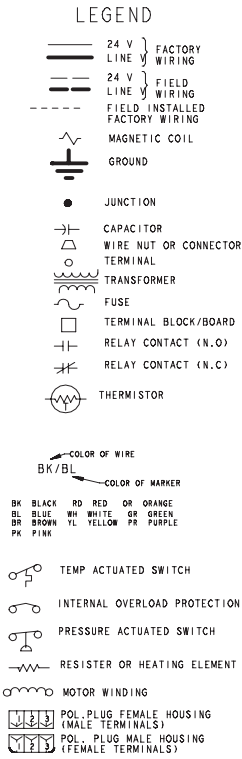

Electrical Data

Schematic Diagrams 3 & 4 Ton Units

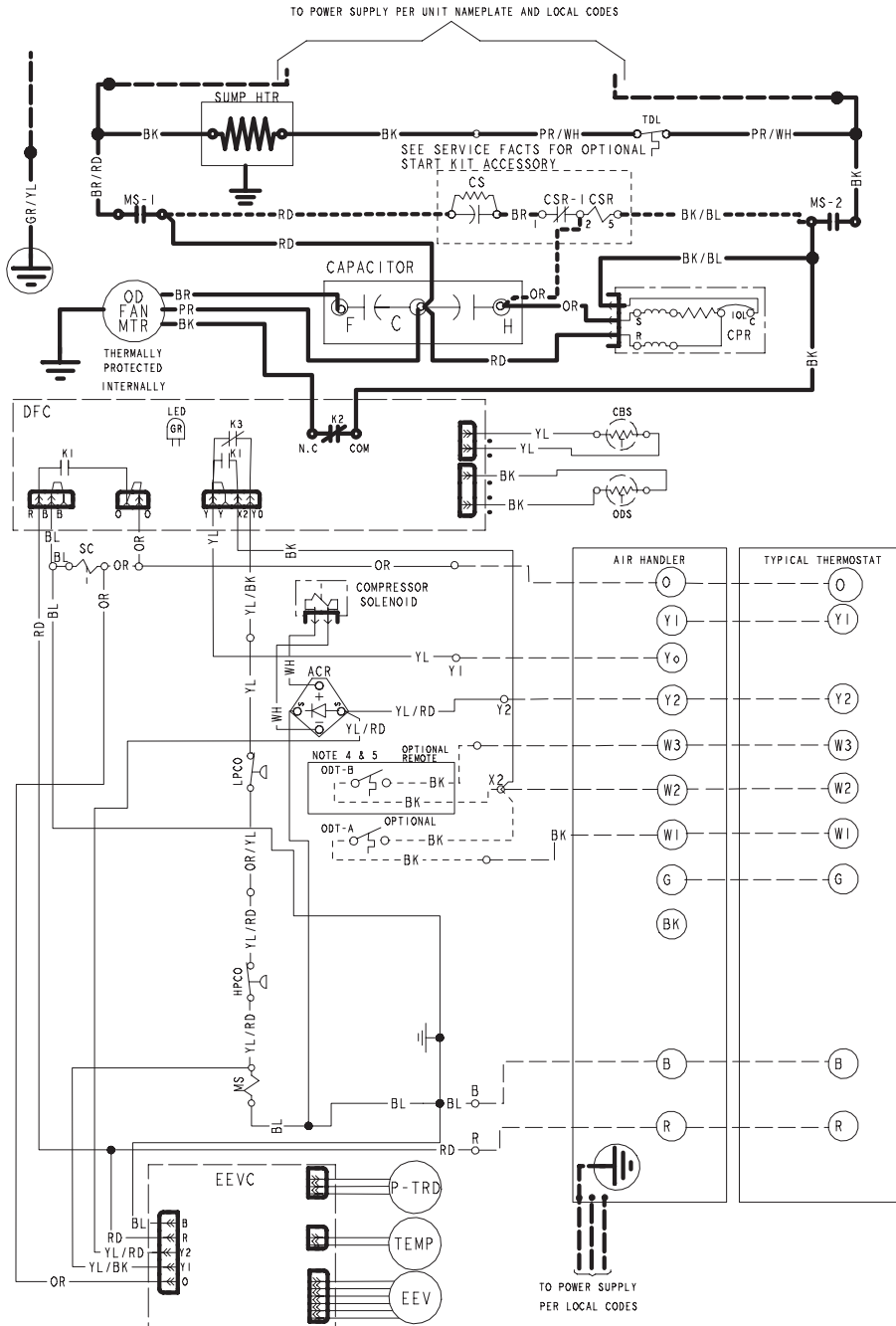

- ACR A/C RECTIFIER
- CBS COIL BOTTOM SENSOR
- CF FAN CAPACITOR
- CN WIRE CONNECTOR
- CPR COMPRESSOR
- CR RUN CAPACITOR
- CS STARTING CAPACITOR
- CSR CAPACITOR SWITCHING RELAY
- DFC DEFROST CONTROL
- EEV ELECTRONIC EXP VALVE
- EVV ELECTRONIC EXP VALVE CONTROL
- F INDOOR FAN RELAY
- HPCO HIGH PRESSURE CUTOFF SWITCH
- IOL INTERNAL OVERLOAD PROTECTOR
- LPCO LOW PRESSURE CUTOFF SWITCH
- MS COMPRESSOR MOTOR CONTACTOR
- ODA OUTDOOR ANTICIPATOR
- OFT OUTDOOR FAN THERMOSTAT
- ODS OUTDOOR TEMPERATURE SENSOR
- ODT OUTDOOR THERMOSTAT
- P-TRD PRESSURE TRANSDUCER
- SC SWITCH OVER VALVE SOLENOID
- SM SYSTEM ON-OFF SWITCH
- TDL DISCHARGE LINE THERMOSTAT
- TNS TRANSFORMER

WARNING
HAZARDOUS VOLTAGE!
DISCONNECT ALL ELECTRICAL POWER INCLUDING REMOTE DISCONNECTS BEFORE SERVICING.
Failure to disconnect power before servicing can cause severe personal injury or death.

CAUTION
USE COPPER CONDUCTORS ONLY!
UNIT TERMINALS ARE NOT DESIGNED TO ACCEPT OTHER TYPES OF CONDUCTORS.
Failure to do so may cause damage to the equipment.

- NOTES:
1. BE SURE POWER SUPPLY AGREES WITH EQUIPMENT NAMEPLATE.
 2. POWER WIRING AND GROUNDING OF EQUIPMENT MUST COMPLY WITH LOCAL CODES.
 3. LOW VOLTAGE WIRING TO BE NO. 18 AWG MINIMUM CONDUCTOR.
 4. ODT-B MUST BE SET LOWER THAN ODT-A
 5. IF ODT-B IS NOT USED, CONNECT A JUMPER WIRE FROM W3 TO W2. IF ODT-A IS NOT USED, CONNECT A JUMPER WIRE FROM W2 TO W1.
 6. IF ELECTRIC HEATER DOES NOT HAVE A 3RD CONTACTOR (CH), CONNECT A JUMPER WIRE FROM W3 TO W2. IF ELECTRIC HEATER DOES NOT HAVE A 2ND CONTACTOR (BH), CONNECT A JUMPER WIRE FROM W2 TO W1.
 7. WITH Y1 ENERGIZED, INDOOR FAN IS 1ST STAGE AIRFLOW.
 8. WITH Y1 & Y2 ENERGIZED, INDOOR FAN IS 2ND STAGE AIRFLOW.
 9. SEE AIR HANDLER INSTALLER GUIDE FOR DIP SWITCH CONFIGURATIONS.

























FOR CANADIAN INSTALLATIONS
POUR INSTALLATIONS CANADIENNES

CAUTION: NOT SUITABLE FOR USE ON SYSTEMS EXCEEDING 150V-TO-GROUND
ATTENTION: NE CONVIENT PAS AUX INSTALLATIONS DE PLUS DE 150 V A

Drw. D159896P01

Electrical Data

Schematic Diagrams 3 & 4 Ton Units

- LEGEND**
-  24 V } FACTORY LINE WIRING
 -  24 V } FIELD WIRING
 -  FIELD INSTALLED FACTORY WIRING
 -  MAGNETIC COIL
 -  GROUND
 -  JUNCTION
 -  CAPACITOR
 -  WIRE NUT OR CONNECTOR
 -  TERMINAL
 -  TRANSFORMER
 -  FUSE
 -  TERMINAL BLOCK/BOARD
 -  RELAY CONTACT (N.O.)
 -  RELAY CONTACT (N.C.)
 -  THERMISTOR
 -  TEMP ACTUATED SWITCH
 -  INTERNAL OVERLOAD PROTECTION
 -  PRESSURE ACTUATED SWITCH
 -  RESISTOR OR HEATING ELEMENT
 -  MOTOR WINDING
 -  POL. PLUG FEMALE HOUSING (MALE TERMINALS)
 -  POL. PLUG MALE HOUSING (FEMALE TERMINALS)
 -  BK/BL ← COLOR OF WIRE
 -  ← COLOR OF MARKER
- BK BLACK RD RED OR ORANGE
 BL BLUE WH WHITE GR GREEN
 BR BROWN YL YELLOW PR PURPLE
 PK PINK

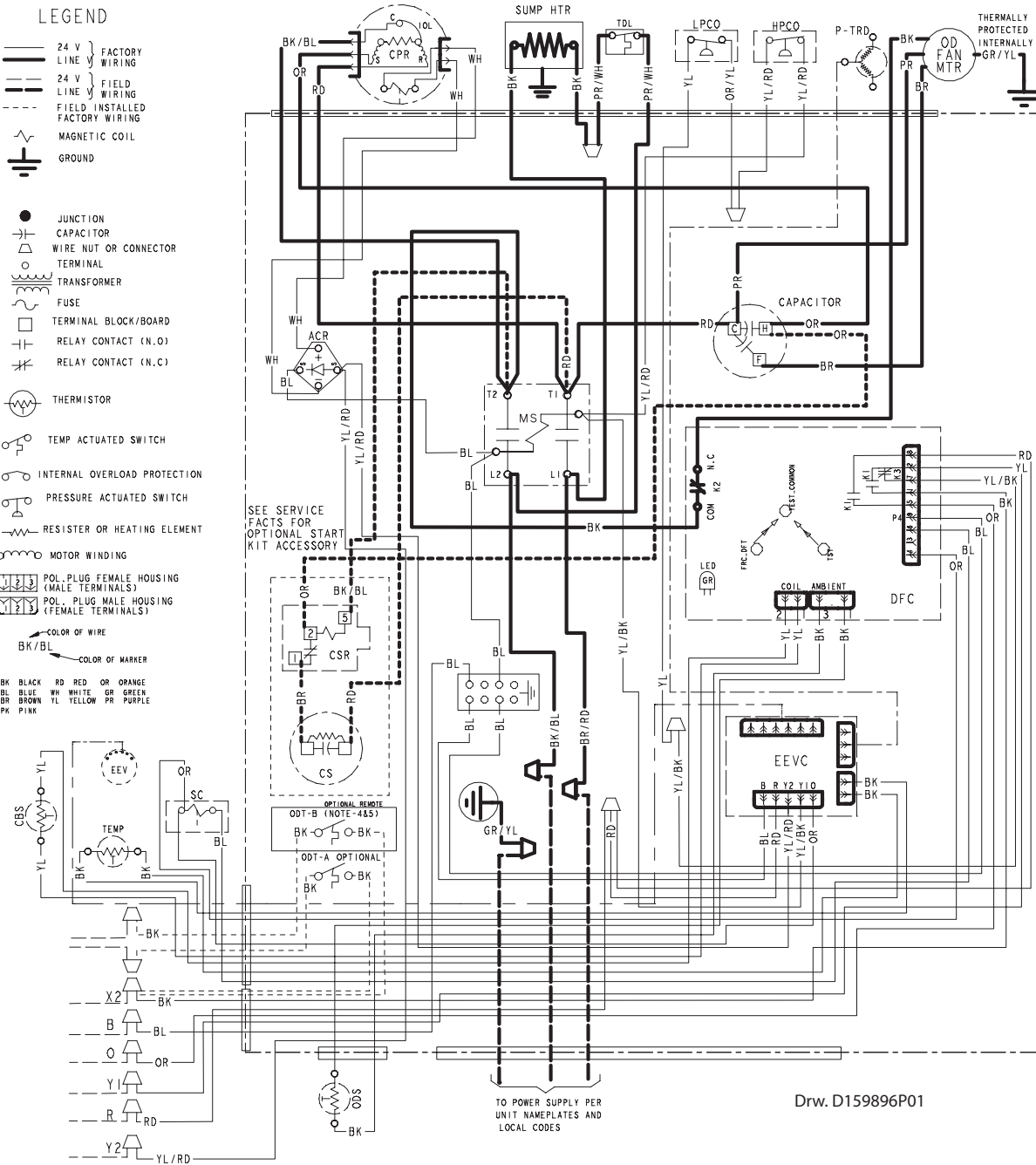

Drw. D159896P01

Electrical Data

Schematic Diagrams 5 Ton Units

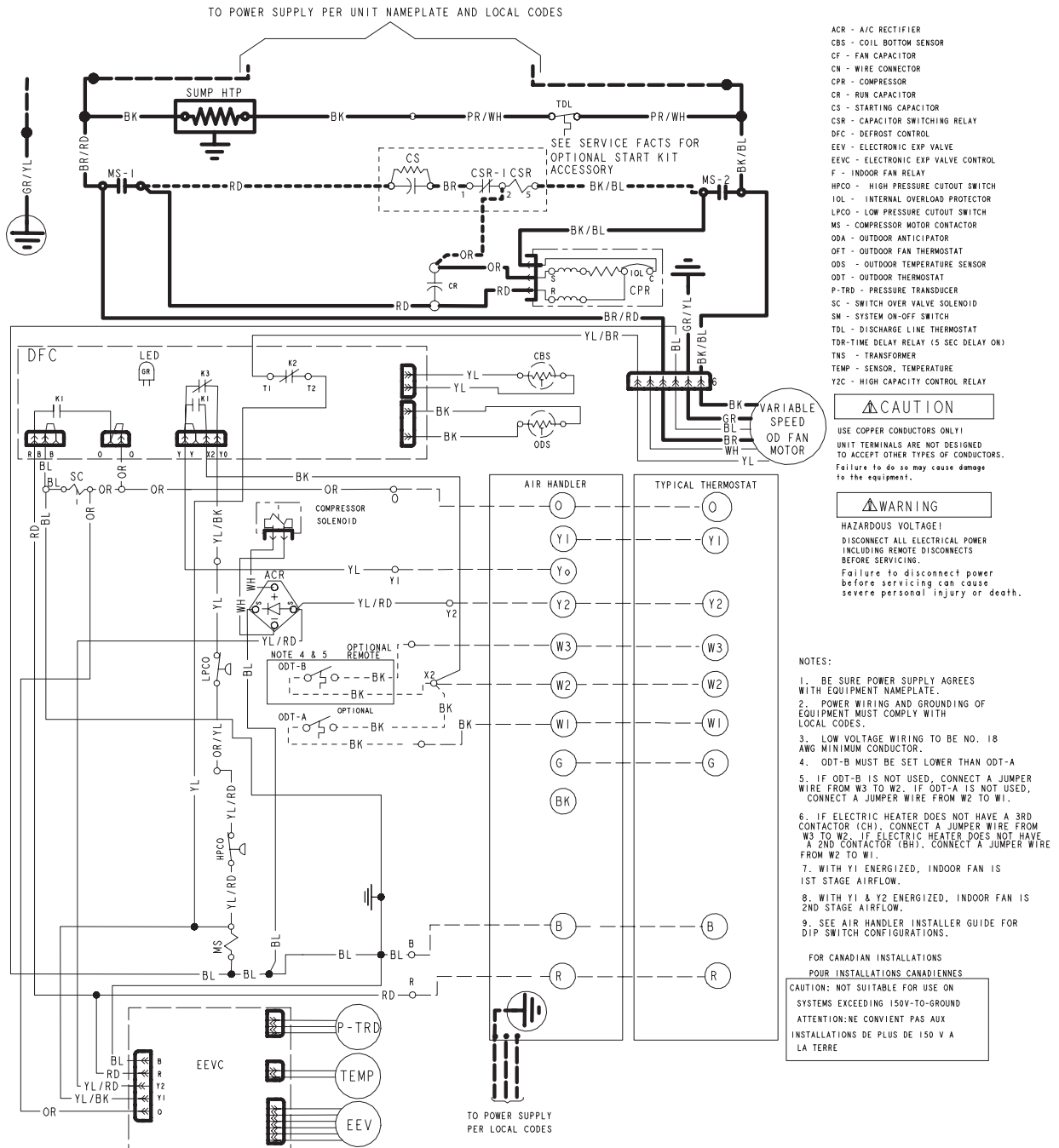

Electrical Data

Schematic Diagrams 5 Ton Units

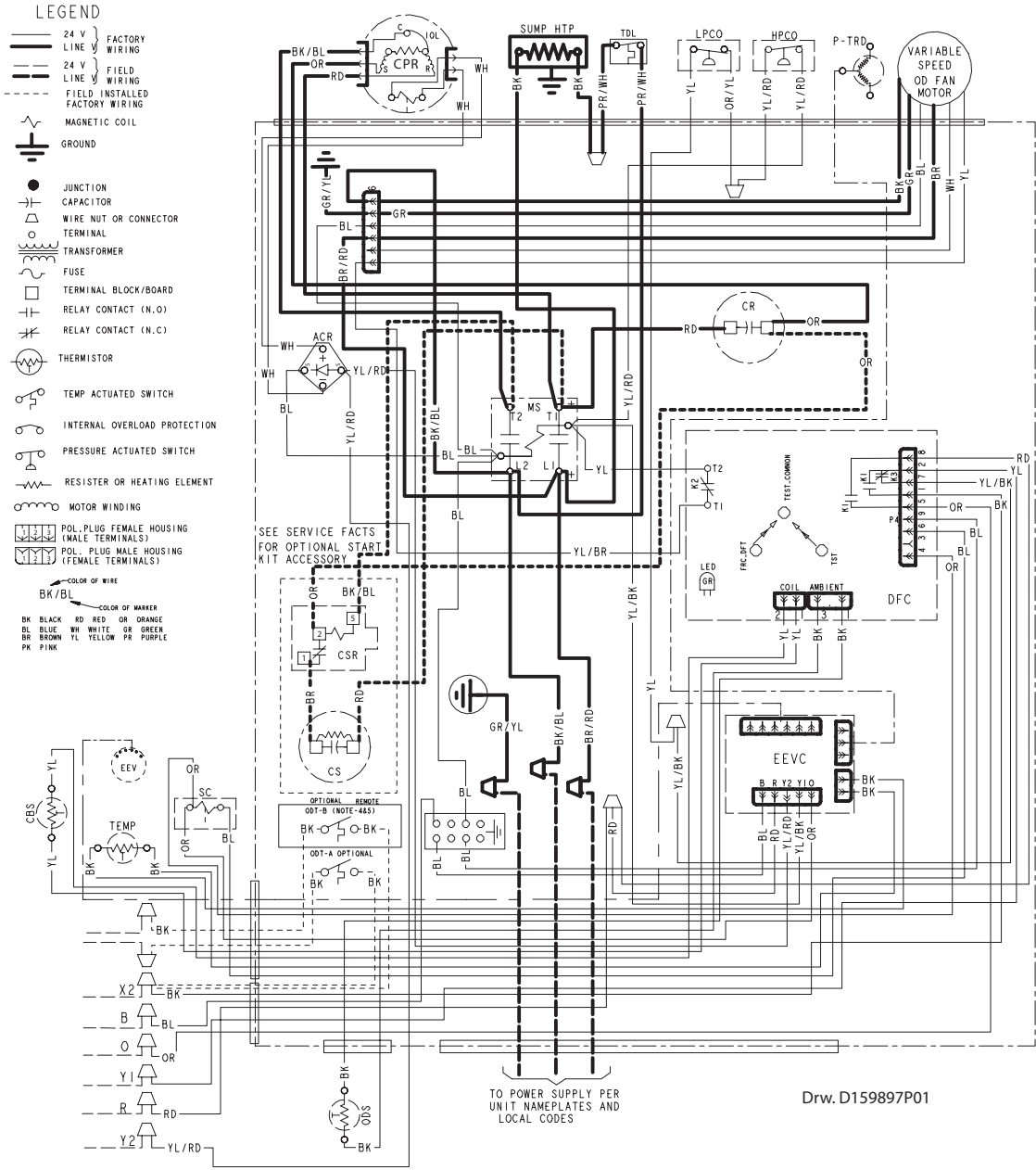

Dimensions

4TWX7 Outline Drawing

Note: All dimensions are in MM (Inches).

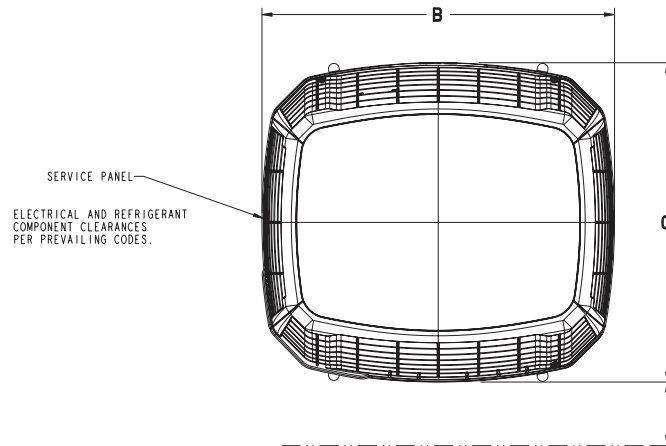

UNIT SHOULD BE PLACED SO ROOF RUN-OFF WATER DOES NOT POUR DIRECTLY ON UNIT, AND SHOULD BE AT LEAST 305 (12") FROM WALL AND ALL SURROUNDING SHRUBBERY ON TWO SIDES. OTHER TWO SIDES UNRESTRICTED.

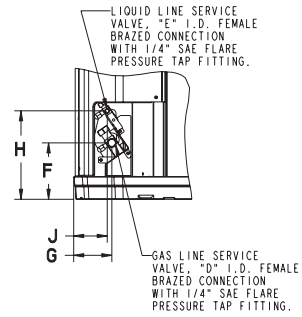
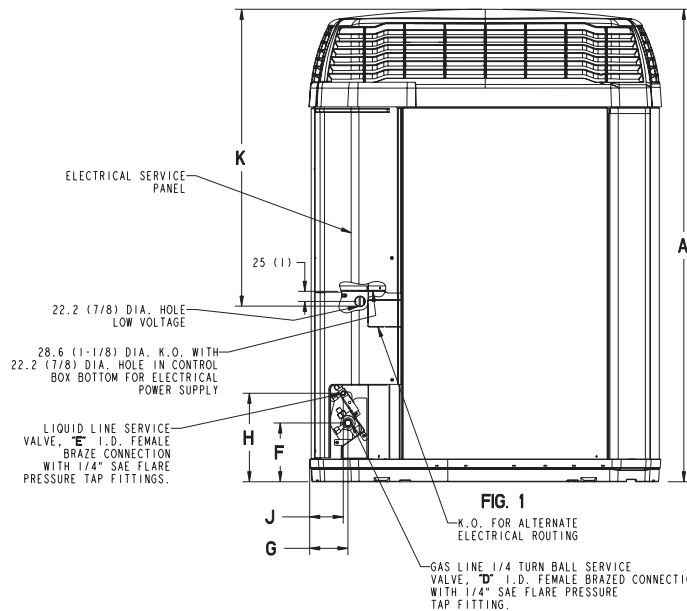

FIG. 2

MODELS	BASE	A	B	C	D	E	F	G	H	J	K
4TWX7024E	4	1205.024 (47.435)	946 (37-1/4)	870 (34-1/4)	5/8	3/8	152 (6)	98 (3-7/8)	219 (8-5/8)	86 (3-3/8)	973.024 (38.31)
4TWX7036E	4	1307.024 (51.435)	946 (37-1/4)	870 (34-1/4)	3/4	3/8	152 (6)	98 (3-7/8)	219 (8-5/8)	86 (3-3/8)	668.024 (26.31)
4TWX7048E	4	1307.024 (51.435)	946 (37-1/4)	870 (34-1/4)	7/8	3/8	152 (6)	98 (3-7/8)	219 (8-5/8)	86 (3-3/8)	668.024 (26.31)
4TWX7060E	4	1307.024 (51.435)	946 (37-1/4)	870 (34-1/4)	1-1/8	3/8	152 (6)	98 (3-7/8)	219 (8-5/8)	86 (3-3/8)	668.024 (26.31)

Mechanical Specifications

General

The outdoor condensing units are factory charged with the system charge required for the outdoor condensing unit, ten (10) feet of tested connecting line, and the smallest rated indoor evaporative coil match. This unit is designed to operate at outdoor ambient temperatures as high as 115°F. Cooling capacities are matched with a wide selection of air handlers and furnace coils that are AHRI certified. The unit shall be certified to UL 1995. Exterior is designed for outdoor application.

Casing

Unit casing is constructed of heavy gauge, G60 galvanized steel and painted with a weather-resistant powder paint on all louvers and panels. Corrosion and weatherproof CMBP-G30 DuraTuff™ base.

Refrigerant Controls

Refrigeration system controls include condenser fan, compressor contactor and high pressure switch. High and low pressure controls are inherent to the compressor. A factory installed liquid line drier is standard.

Compressor

The Climatuff® 2-stage compressor features internal over temperature and pressure protection and hermetic motor. Other features include centrifugal oil pump and modular plugs for electrical connections.

Condenser Coil

The outdoor coil provides low airflow resistance and efficient heat transfer. The coil is protected on all four sides by louvered panels.

Low Ambient Cooling

As manufactured, this unit has a cooling capability to 55°F. For low ambient cooling below 55° see Application Guide APP-APG013-EN.



Trane - by Trane Technologies (NYSE: TT), a global climate innovator - creates comfortable, energy efficient indoor environments for commercial and residential applications. For more information, please visit trane.com or tranetechnologies.com.



The AHRI Certified mark indicates Trane U.S. Inc. participation in the AHRI Certification program. For verification of individual certified products, go to ahridirectory.org.

Trane has a policy of continuous data improvement and it reserves the right to change design and specifications without notice. We are committed to using environmentally conscious print practices.