



### WARNING

**WARNING — THE INSTALLATION MUST BE CARRIED OUT BY A QUALIFIED TECHNICIAN.**

1. DO NOT open. No user serviceable parts inside
2. ODDMF inline fans are intended for indoor use only
3. Install with duct on inlet and duct and/or fan silencer on exhaust of fan
4. Speed control MUST be connected for the ODDMF inline fans to function
5. Ensure the product is unplugged from the electrical outlet before relocating, servicing or cleaning

### A P P L I C A T I O N N O T I C E

- For general ventilation use only
- Install guard screens if personnel have access to inlet or exhaust of fan
- DO NOT use to exhaust hazardous explosive materials and vapours
- Ensure that the fan is switched off from the supply mains before removing guard
- Precautions must be taken to avoid the back-flow of gases, in this case, a check valve is necessary
- To disconnect, first turn the unit off, grip the plug and pull from the wall outlet. NEVER pull the plug by the cord
- DO NOT pull the cord too hard as it could damage and fray. If the supply cord is damaged, it must be replaced by the manufacturer, its service agent or similarly qualified persons in order to avoid an electrical hazard
- DO NOT allow the power cord or any other parts of the fan to touch hot surfaces, open flames, cooking or other heating appliances and DO NOT place near hot gas or electric burners
- Turn the unit off when moving to another location and before cleaning
- DO NOT operate if housing is damaged
- Ensure all the packaging has been removed and that the voltage used corresponds to the voltage indicated on the rating plate
- DO NOT cover any openings on the fan or insert objects or parts of the body into any of its openings when fan is on or off
- To protect against electric shock, do not immerse unit, plug or rcord in water or other liquids
- Keep cord away from areas where it could be walked on or tripped over

**DO NOT use this fan in the following circumstances:**

- Environment with significant dust
- Environmental humidity is above 90%
- Operating Temperature is less than -10°C, or above +60°C
- Places where children or pets have easy access to the fan blades
- Flammable or hazardous atmosphere, near explosive gases, or chemical dust

### CAUTION

**PLEASE READ INSTRUCTION BEFORE COMMENCING INSTALLATION AND RETAIN FOR FUTURE REFERENCES.**

**Electrical products can cause death or injury, or damage to property.**

**If in any doubt about the installation or use of this product, consult a competent technician.**

### CLEANING & MAINTENANCE

- Wipe the unit and blades with a damp cloth
- DO NOT spray water or liquid on or into the fan
- DO NOT clean the units with cloths that have metal parts
- Clean the unit regularly to ensure the blades can move freely
- DO NOT use cleaning detergent or chemicals to clean the fan
- NEVER immerse in water or let water enter the fan controller outlet
- DO NOT clean while the unit switch is on. Turn off and unplug the unit

### FEATURES

This EC Mix Flow Inline Fan is powered by cutting-edge EC motor featuring high static air pressure, aerodynamically-optimized airflow, quiet operation, and extremely high efficiency. They are ideal for residential, commercial and industrial ventilation, and even hydroponic ventilation (exhaust and intake). Multiple Speed Control Signals available (Potentionmeter ; PWM; 0-10V , Tachometer)\*

## INSTALLATION GUIDE

**WARNING!**  
**MUST CONNECT SECURELY TO SPEED CONTROL BEFORE POWER UP**

- ❖ DO NOT deform fan bracket or fan housing
- ❖ DO NOT install fan on sheet rock or weak surface
- ❖ Always install the fan at the height of 2.1m or above
- ❖ Unpack and check fan for damage. Ensure that the fan impeller spins freely and not touching fan housing.
- ❖ Use a pre-filter on the absorption axis to prevent dust, oil and other foreign substances from building up on the impeller. Build up of dust and or foreign material can cause out of balance impeller and excessive vibration. Excessive vibration will reduce fan lifetime.
- ❖ Use the appropriate attachment screws for the surface material being selected to mount the fan. Use the supplied mounting bracket or hanger.
- ❖ After completing the installation, electrical work and duct work, perform the test operation to confirm if the fan operates normally
- ❖ After turning the power on, the fan should rotate freely, and build up speed normally
- ❖ If there is abnormal noise or no rotation, check all connections as well as power supply

### Wall Mounted Installation

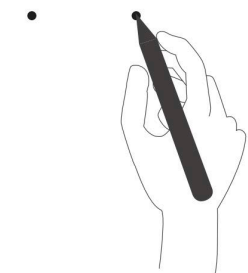

**1**  
 Mark the screw position on the wall



**2**  
 Punch holes in the wall

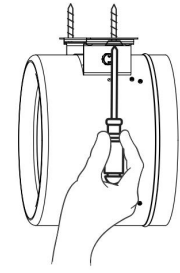

**3**  
 Screw the fan onto the wall

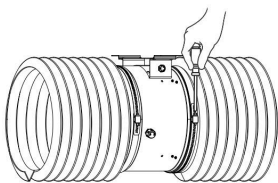

**4**  
 Connect the ducts onto two sides with clamps

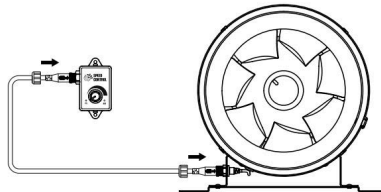

**5**  
 Connect the speed control to the fan and make sure the connection is in place and fastened

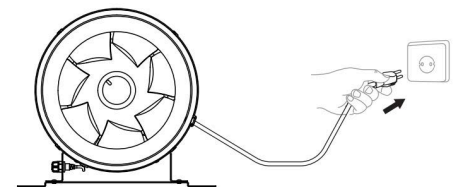

**6**  
 Power up the fan

### Hang Installation

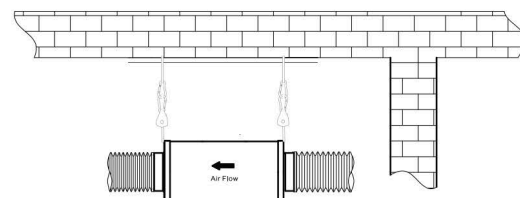
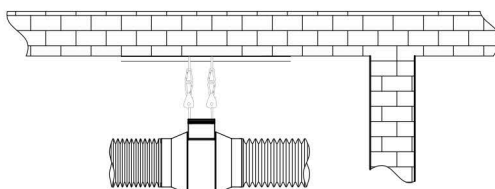

## INSTALLATION GUIDE

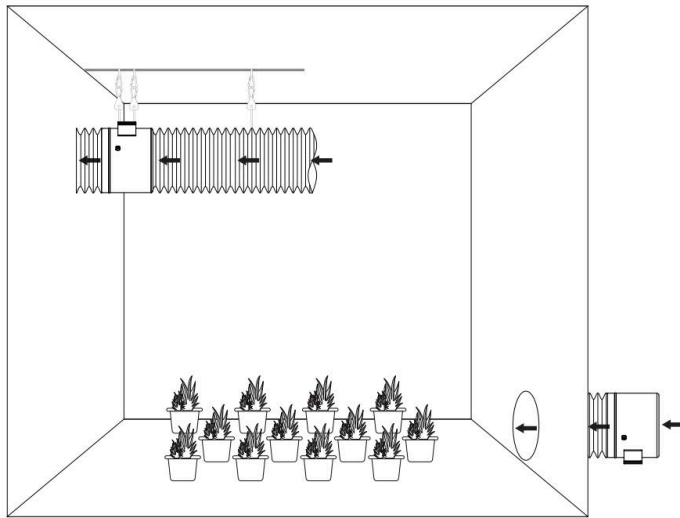

### Intake and Exhaust

This fan can be used as either an intake fan or exhaust fan in grow rooms or tents to achieve optimal whole space ventilation.

- ❖ Used as the intake fan or opening:  
If it is NOT used as a fan, it must be situated at a bottom corner of your grow space
- ❖ Used as the exhaust fan:  
It must be hung (see the right side diagram) or mounted at the highest opposite corner

## PRODUCT CONTENT DIAGRAM

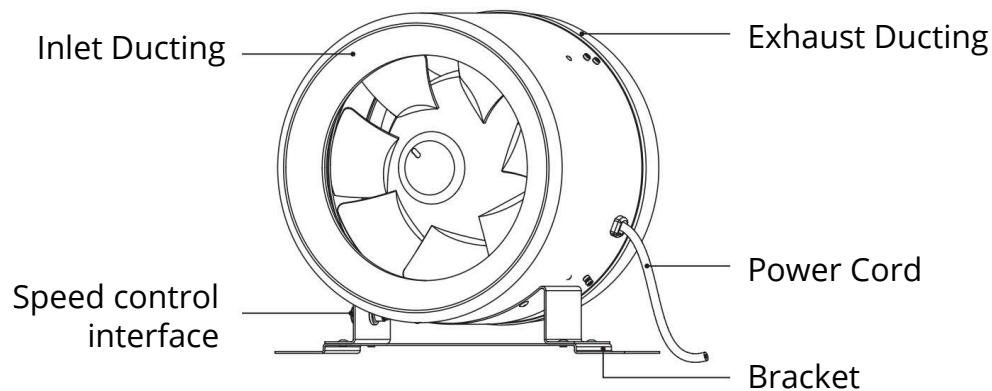

## FAN CONTROLS

**Standard Control** — All EC fans go with a portable variable speed controller or wall mounted controller



### Portable Speed Controller

- ❖ Simple & portable
- ❖ 0-100% variable speed controller by potentiometer



### Wall Mounted Controller

- ❖ Fits into the in-wall installation of
- ❖ Provides 0-100% variable speed control range

- ❖ ODDMF Inline Series Fans offer a standard variable speed controller via potentiometer

- ❖ It can also offer multiple way to control the fan speed, supporting varies HVACR system and compatible with other controllers by PWM & 0-10V

## FAN CONTROLS

### DIY 4-Pins Control

EC fan with multi speed control signals is packed with DIY 4 pins connection cable.

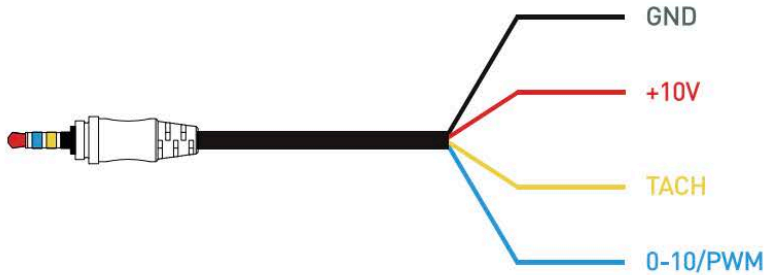

#### Max.Speed

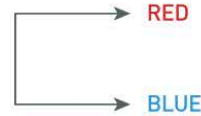

#### Speed Control via 0-10V

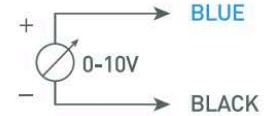

#### Speed Control via PWM

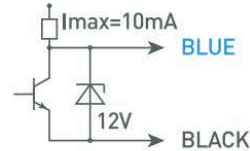

#### Speed Control via POT

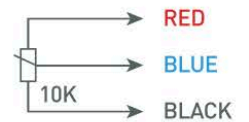

## OPTIONAL CONTROLS & ACCESSORY

EC fan with multiple speed control signals offers great flexibility and compatibility of speed control with various accessory: Smart control, remote control, wall mounted variable control, controller adapters and extension cable.



### Smart Controller with Probe (sold separately)

6 speed controller with thermal probe for monitoring environmental temperature, accurate ventilation and energy saving, supporting control of up to 4 EC fans simultaneously and mode selection of manual, auto and alert.



### Adapter to Other 3 Pins Controller (sold separately)

This adapter has a male 3.5MM TRRS Jack and female 3PINS connector it gives additional support for using SigilVentus EC fan controller in the market, e.g. GAS type No.150 Digital EC fan controller, GAS type No.501 Digital EC 5 controller



### Wireless Remote with Receiver (sold separately)

Allows you to control your EC fan wirelessly. 6 preset speed levels (15-100% output). 50ft / 15m signal range, which works through walls, floors and ceilings. Ideal for fans installed in hard to reach places.



### Adapter to Other RJ45 Controllers (sold separately)

This adapter is with 3.5MM TRRS male jack and RJ45 female connector it gives additional support for using SigilVentus EC fan controller in the market, e.g. PRIMA KLIMA ECTC-1M display controller



### 3.5MM TRRS Jack Extension Control Cable (sold separately)

5 meters long extension cable for flexible controller installation in a long distance within 10 meters.



### Full Speed Plug (sold separately)

This plug is useful when no speed control is required. The fan will work at MAX. SPEED once plugged.

ORTECH reserves the right to modify at any time, without notice, any or all of our product's features, designs, components and specifications to meet market changes.