



WARNING

TO REDUCE THE RISK OF FIRE, ELECTRIC SHOCK, OR INJURY TO PERSONS, OBSERVE THE FOLLOWING:

1. Use this unit only in the manner intended by the manufacturer. If you have questions, contact the manufacturer at the address or telephone number listed in the warranty
2. Before servicing or cleaning unit, switch power off at service panel and lock the service disconnecting means to prevent power from being switched on accidentally. When the service disconnecting means cannot be locked, securely fasten a prominent warning device, such as a tag, to the service panel
3. Installation work and electrical wiring must be done by a qualified person(s) in accordance with all applicable codes and standards
4. Sufficient air is needed for proper combustion and exhausting of gases through the flue (chimney) of fuel burning equipment to prevent backdrafting. Follow the heating equipment manufacturer's guideline and safety standards such as those published by the National Fire Protection Association (NFPA), and the American Society for Heating, Refrigeration and Air Conditioning Engineers (ASHRAE), and the local code authorities
5. When cutting or drilling into wall or ceiling, do not damage electrical wiring and other hidden utilities
6. Ducted fans must always be vented to the outdoors
7. Acceptable for use over a tub or shower when connected to a GFCI (Ground Fault Circuit Interrupter) — protected branch circuit (ceiling installation only)
8. This unit must be grounded

CAUTION

1. For general ventilating use only. Do not use to exhaust hazardous or explosive materials and vapours
2. This product is designed for installation in ceilings up to a 12/12 pitch (45°). Duct connector must point up.
DO NOT MOUNT THIS PRODUCT IN A WALL
3. To avoid motor bearing damage and noisy and/or unbalanced impellers, keep drywall spray, construction dust etc. off power unit
4. Please read specification label on product for further information and requirements

CLEANING & MAINTENANCE

For quiet and efficient operation, long life, and attractive appearance — remove the plate and vacuum interior of unit with the dusting brush attachment. The motor is permanently lubricated and never needs oiling. If the motor bearings are making excessive or unusual noises, replace the motor with the exact service motor. The impeller should also be replaced.

OPERATION

Use an on/off switch to operate this fan. See "Connect Wiring" for details.

User Setting

The control box, located inside the fan housing, has 3 separate adjustments:

- 1) The low airflow knob adjusts the lower airflow from 30CFM up to the airflow rate of the high fan speed determined by the toggle switch setting
- 2) The time delay knob is adjusted from 3 to 30 minutes and will switch the fan to the low speed setting after the switch II is turned off for the set period of time
- 3) The toggle switch will adjust the upper fan speed setting from 80 to 140

To Turn Fan ON

Turn the switch I (according to the following "CONNECT ELECTRICAL WIRING") ON.

- Fan will run at the certified airflow rate if the switch II is ON
- Fan will run at the user-adjustable airflow rate if the switch II is OFF

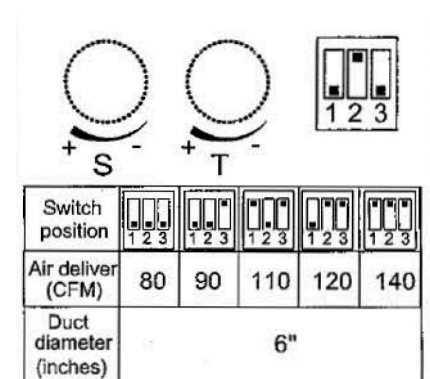

OPERATION

To Use Fan Time Delay Airflow Rate Change

1. Turn the switch I ON
2. Turn the switch II ON — fan will run at the certified airflow rate
3. When the switch II is turned OFF, fan will continue to run at the certified airflow rate until the user-adjustable time delay has elapsed, and then will automatically change to the user-adjustable airflow rate

To Turn Fan OFF

Turn the switch I OFF

To change the pre-selected airflow, adjust the control switches as per the table above. ■ is the position of the switch

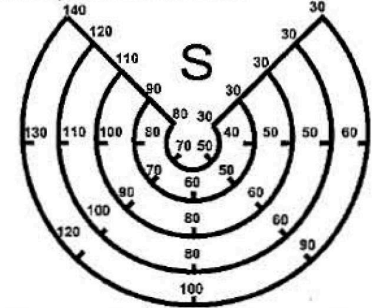

INSTALLATION GUIDE

Plan the Installation

1. Do not use in a cooking area
2. 2 ways to connect ductwork to a factory-shipped unit

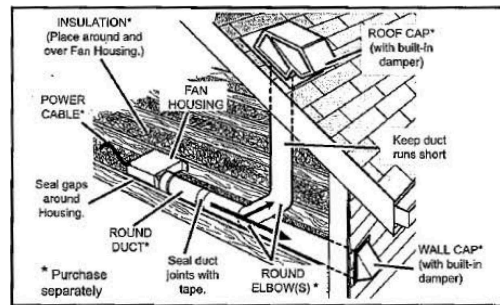
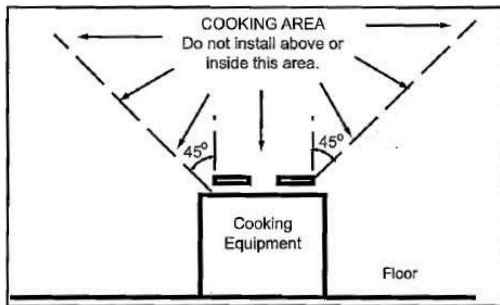

Assembly Instructions

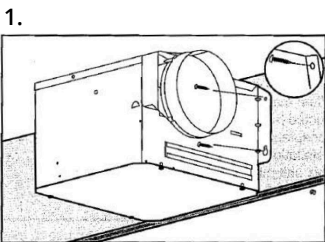

Mount Housing to Joist or I-Joist
Hold the housing so that it is in contact with the joist. Attach the housing with four (4) screws to the joist through the holes in each mounting flange

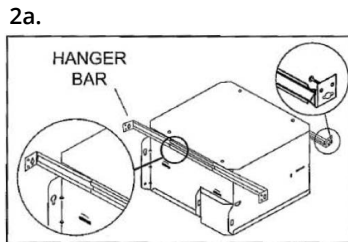

Mount with Hanger Bars
Slide hanger bars have been provided, which allow the housing to be positioned accurately anywhere between the framing. The bars span up to 24" and can be used on all types of framing: I-joist, standard joist, and truss construction. Slide hanger bars onto housing and adjust as needed to fit between framing.

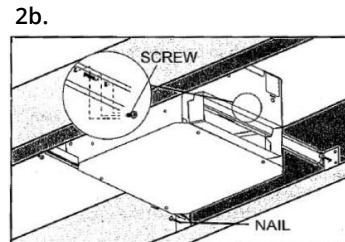

Extend the hanger bars to the width of the framing, holding the ventilator in place. Secure hanger bars to framing using one screw on each end of hanger bar. Select a proper hole and secure the hanger bars together using flange screws

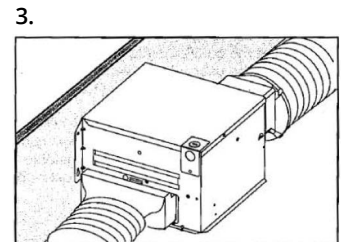

Install Ductwork
Connect the ductwork (not included) to the damper/duct connector, and the ductwork to a roof or wall cap (not included). Using tape (not included), secure all the ductwork connections so that they are air tight

CONNECT ELECTRICAL WIRING

Run 120V AC house wiring to the location of the fan. Use only UL-approved connectors (not included) to attach the house wiring to the wiring plate. Refer to the wiring diagram, and connect the wires as shown.

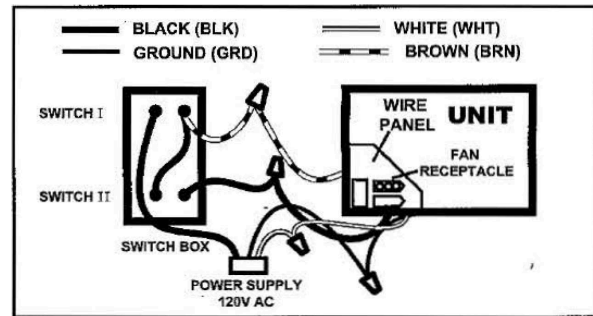
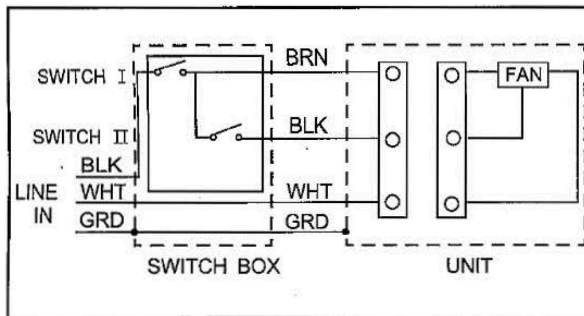

SERVICE PARTS

PART	PART NAME	Qty.
1	Plate	1
2	Motor Plate	1
3	Motor	1
4	Blower Wheel	1
5	Wire Panel / Harness Assembly	1
6	Damper / Duct Connector	1
7	Wiring plate	1
8	Housing	1
9	Damper / Duct Connector	1
10	Hanger Bar Kit	3
11	Power box (For model ODDIN-110)	1
a	Nut, Hex Lock	4
b	Washer	4
c	Screw	1
d	Isolator	4
e	Screw	1
f	Screw	4

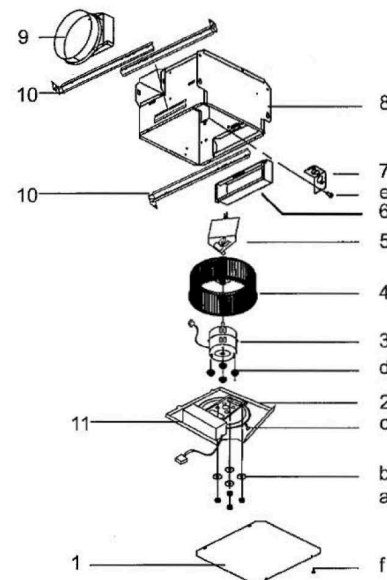

* Blower Assembly includes part 4,3,d,2,c,b,a.

Replacement installation: Remove the screw (part c), then take out the motor plate (part 2) from the housing (part 8) by pushing down the rib in the plate while pulling out on the side of the housing. Replace the broken parts.

WARNING: Before replacing, be sure to turn off power at power source.

WARRANTY

ONE YEAR LIMITED WARRANTY from the original date of purchase against defects in material and workmanship. This warranty is limited up to the amount of the original purchase price of the product, excluding any labour cost. For inquiries, please visit www.ortechindustries.com or call 1-888-543-6473.